

**HRT 55**

**Diffuse reflection light scanner with background suppression**

en 01-2015/03 50128566



**Dimensioned drawing**

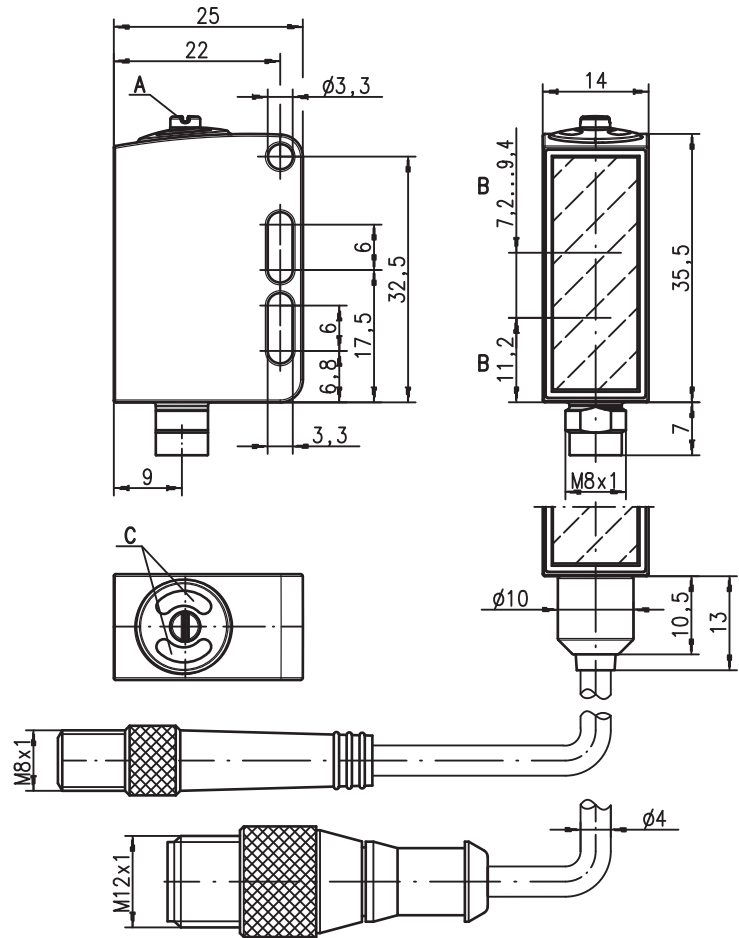

- A** Adjustment screw
- B** Optical axis
- C** Indicator diodes

**5 ... 600mm**  
250mm with  
black-white error < 10%

10 - 30 V  
DC

1 kHz

stainless steel  
316 L

- Diffuse reflection light scanner with infrared light and adjustable background suppression
- Exact scanning range adjustment through 8-turn potentiometer
- Very good black/white behavior and reliable switching nearly independent of the object or background properties
- 316L stainless steel housing in Hygiene-Design
- Enclosed optics design prevents bacterial carry-overs
- ECOLAB and CleanProof+ tested
- Paperless device identification
- Scratch resistant and non-diffusive plastic front cover
- A<sup>2</sup>LS- Active Ambient Light Suppression
- Push-pull switching outputs
- High switching frequency for detection of fast events

**Electrical connection**

Connector, 4-pin

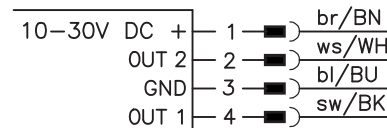

Cable, 4 wires

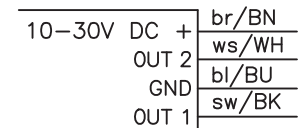

Connector, 3-pin



**Accessories:**

(available separately)

- Cable with M8 or M12 connector (K-D ...)
- Cable for food and beverages
- Mounting devices

We reserve the right to make changes • DS\_HRT55\_en\_50128566.fm



## Specifications

### Optical data

Typ. scanning range limit <sup>1)</sup>	5 ... 600mm
Scanning range <sup>2)</sup>	see tables
Adjustment range <sup>1)</sup>	15 ... 600mm
Light beam characteristic	focussed at 200mm
Light source <sup>3)</sup>	LED (modulated light)
Wavelength	880nm (infrared)

### Timing

Switching frequency	1,000Hz
Response time	0.5ms
Delay before start-up	≤ 300ms (acc. to. IEC 60947-5-2)

### Electrical data

Operating voltage $U_B$ <sup>4)</sup>	10 ... 30VDC (incl. residual ripple)
Residual ripple	≤ 15% of $U_B$
Open-circuit current	≤ 15mA
Switching output	.../66 <sup>5)</sup> 2 push-pull switching outputs pin 2: PNP dark switching, NPN light switching pin 4: PNP light switching, NPN dark switching
	.../6 <sup>5)</sup> 1 push-pull switching output pin 4: PNP light switching, NPN dark switching
	.../6D <sup>5)</sup> 1 push-pull switching output pin 4: PNP dark switching, NPN light switching
	.../44 2 PNP switching outputs, complementary
	.../4 1 PNP switching output light switching, pin 2: not connected <sup>6)</sup>
	.../22 2 NPN switching outputs, complementary light/dark switching
Function	≥ ( $U_B - 2V$ ) / ≤ 2V
Signal voltage high/low	max. 100mA
Output current	adjustable via 8-turn potentiometer
Scanning range	

### Indicators

Green LED	ready
Yellow LED	object detected - reflection

### Mechanical data

Housing	AISI 316L stainless steel, DIN X2CrNiMo17132, W.No1.4404
Housing design	WASH-DOWN-Design
Housing roughness <sup>7)</sup>	$R_a \leq 2.5$
Connector	AISI 316L stainless steel, DIN X2CrNiMo17132, W.No1.4404
Optics cover	coated plastic (PMMA), scratch resistant and non-diffusive
Operation	plastic (TPV-PE), non-diffusive
Weight	with M8 connector: 40g with 200mm cable and M12 connector: 60g with 5000mm cable: 110g
Connection type	M8 connector, 4-pin, 0.2m cable with M12 connector, 4-pin, 5m cable, 4 x 0.20mm <sup>2</sup>

### Environmental data

Ambient temp. (operation/storage)	-30 °C ... +70 °C / -30 °C ... +70 °C
Protective circuit <sup>8)</sup>	2, 3
VDE safety class	III
Degree of protection	IP 67, IP 69K <sup>9)</sup>
Environmentally tested acc. to	ECOLAB, CleanProof+ tested in accordance with ECOLAB and CleanProof+ (see Remarks)
Chemical resistance	
Light source	exempt group (in acc. with EN 62471)
Standards applied	IEC 60947-5-2
Certifications	UL 508, C22.2 No.14-13 <sup>4) 10)</sup>

- 1) Typ. scan. range limit/adjustment range: max. achievable scanning range/adjustment range for light objects (white 90%)
- 2) Scanning range: recommended scanning range for objects with different diffuse reflection
- 3) Average life expectancy 100,000h at an ambient temperature of 25°C
- 4) For UL applications: for use in class 2 circuits according to NEC only
- 5) The push-pull switching outputs must not be connected in parallel
- 6) Pin 2: unassigned, hence especially suitable for the connection to AS-interface I/O coupling modules
- 7) Typical value for the stainless steel housing
- 8) 2=polarity reversal protection, 3=short circuit protection for all transistor outputs
- 9) Only in combination with M12 connector
- 10) These proximity switches shall be used with UL Listed Cable assemblies rated 30V, 0.5A min, in the field installation, or equivalent (categories: CYJV/CYJV7 or PVVA/PVVA7)

## Tables

1	5	600
2	10	500
3	15	400

1	white 90%
2	gray 18%
3	black 6%

□ Scanning range [mm]

## Diagrams

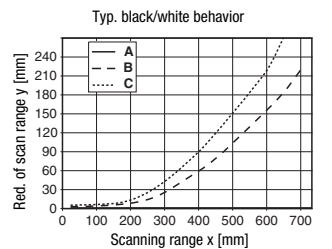
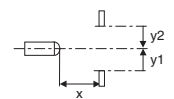
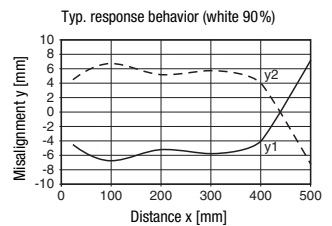

- A white 90%
- B gray 18%
- C black 6%

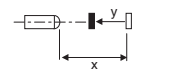

## Remarks

### Operate in accordance with intended use!

- ⚠ This product is not a safety sensor and is not intended as personnel protection.
- ⚠ The product may only be put into operation by competent persons.
- ⚠ Only use the product in accordance with the intended use.

- A list of tested chemicals can be found in the first part of the product description.

### UL REQUIREMENTS

Enclosure Type Rating: Type 1

#### For Use in NFPA 79 Applications only.

Adapters providing field wiring means are available from the manufacturer. Refer to manufacturers information.

**CAUTION** – the use of controls or adjustments or performance of procedures other than those specified herein may result in hazardous radiation exposure.

**ATTENTION** ! Si d'autres dispositifs d'alignement que ceux préconisés ici sont utilisés ou s'il est procédé autrement qu'indiqué, cela peut entraîner une exposition à des rayonnements et un danger pour les personnes.

**HRT 55**
**Diffuse reflection light scanner with background suppression**
**Order guide**

Selection table		Order code →						
<b>Equipment ↓</b>			HRT 55/44, 200-S12 Part no. 50128811					
Switching output	2 x PNP output, complementary	●						
	2 x NPN output, complementary							
	2 x push-pull switching output							
	1 x push-pull switching output							
Switching function	1 PNP light switching and NPN dark switching output							
	1 PNP dark switching and NPN light switching output							
Connection	M8 connector, metal, 4-pin							
	M8 connector, metal, 3-pin							
	200mm cable with M12 connector, 4-pin	●						
	5000mm cable, 4-pin							
Indicators	green LED: ready	●						
	yellow LED: switching output	●						

**Application notes**

- For glossy surfaces (e.g. metals), the light beam should not be incident on the object surface at a right angle. A slight inclination is sufficient for preventing undesired direct reflections. This may result in a reduction in the scanning range.
- Objects should only be moved laterally from the right or left. Moving in objects from the connector side or operating side is to be avoided.
- Outside of the scanning range, the sensor operates as an energetic diffuse reflection light scanner. Light objects can still be reliably detected up to the scanning range limit.
- The sensors are equipped with effective measures for the maximum avoidance of mutual interference should they be mounted opposite one another. Opposite mounting of multiple sensors of the same type should, however, absolutely be avoided.

